

Article number: 439500130

Description: Rota-fix shaft-hub connection F130x180
Steel

Note: Self centering. Very high torque

Measures

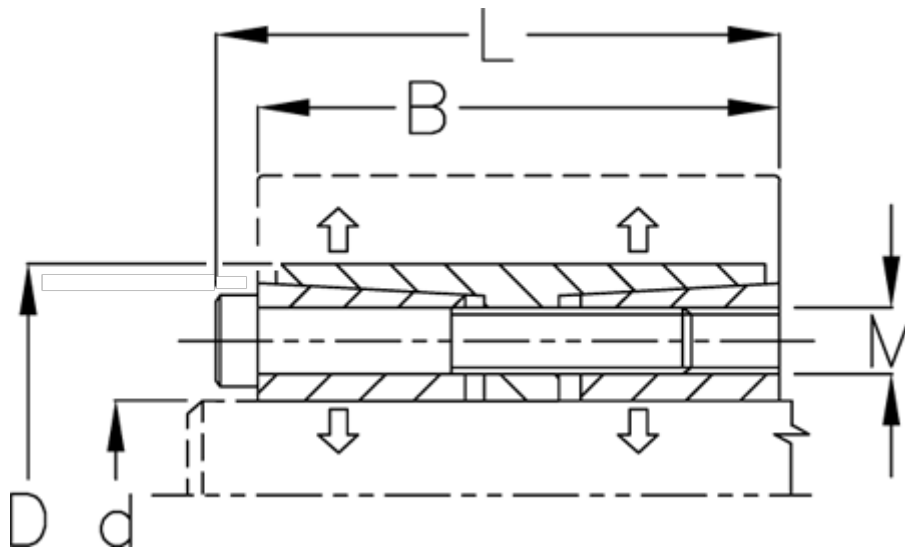

B mm	= 114
d H8 mm	= 130
D mm	= 180
Fit tolerance	= Aksel h8, Nav H8
F kN torque	= 700.0
L mm	= 128
M mm	= M14
P N/mm ² surface pressure on shaft/hub	= 100

Surface roughness	= R? ? 3.2 µm
T N m torque	= 45400
Ts N m bolt tightening torque	= 230.0